

CALYPSO SINGLE LEVER

ASSEMBLY INSTRUCTIONS - PLEASE KEEP FOR FUTURE REFERENCE



IMPORTANT - PLEASE READ THE INSTRUCTIONS FULLY BEFORE STARTING ASSEMBLY

SAFETY AND CARE ADVICE

Important - Please read these instructions fully before starting assembly

- Check you have all the components and tools listed on pages 2 and 3.
- Remove all fittings from the plastic bags and separate them into their groups.
- Keep children and animals away from the work area, small parts could choke if swallowed.
- Make sure you have enough space to layout the parts before starting.

- Do not stand or put weight on the product during assembly, this could cause damage.
- Assemble the item as close to its final position (in the same room) as possible.
- Assemble on a soft level surface to avoid damaging the unit or your floor.
- Parts of the assembly will be easier with 2 people.



- We do not recommend the use of power drill/drivers **for inserting screws**, as this could damage the unit. Only use hand screwdrivers.
- Dispose of all packaging carefully and responsibly.

Care and maintenance

- Only clean using a damp cloth and mild detergent, do not use bleach or abrasive cleaners.
- From time to time check that there are no loose screws on this unit.

- Do not stand on the chair.
- Do not use this chair as step ladder.
- This product should not be discarded with household

waste. Take to your local authority waste disposal centre.

Handy Hints

- Assemble all parts and bolts loosely during assembly, only once the product is complete should you fully tighten the bolts.

- Regularly check and ensure that all bolts and fittings are tightened properly.

COMPONENTS - FITTINGS

PLEASE CHECK YOU HAVE ALL THE PARTS LISTED BELOWS

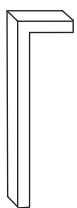

A. KEY

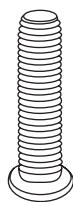

B. M8x30 x2

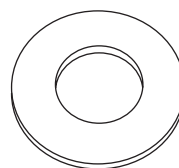

C. Washer x2

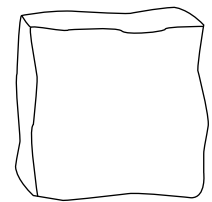

D. BAG

COMPONENTS - PARTS

PLEASE CHECK YOU HAVE ALL THE PARTS LISTED BELOW

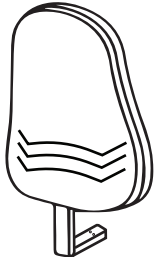

1. BACKREST x1

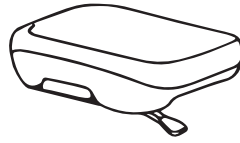

2. SEAT x1
AND MECHANISM x1



3. GAS LIFT x1



4. GAS LIFT COVER x1

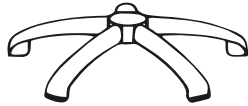

5. BASE x1



6. CASTORS x5



7. MECHANISM COVER x1

ASSEMBLY INSTRUCTIONS

STEP 1

Fitting the Base

Push the five castors (6) into the underside of the base (5).

Insert the gas lift (3) into the base (5). Put the gas lift cover (4) onto the gas lift (3).

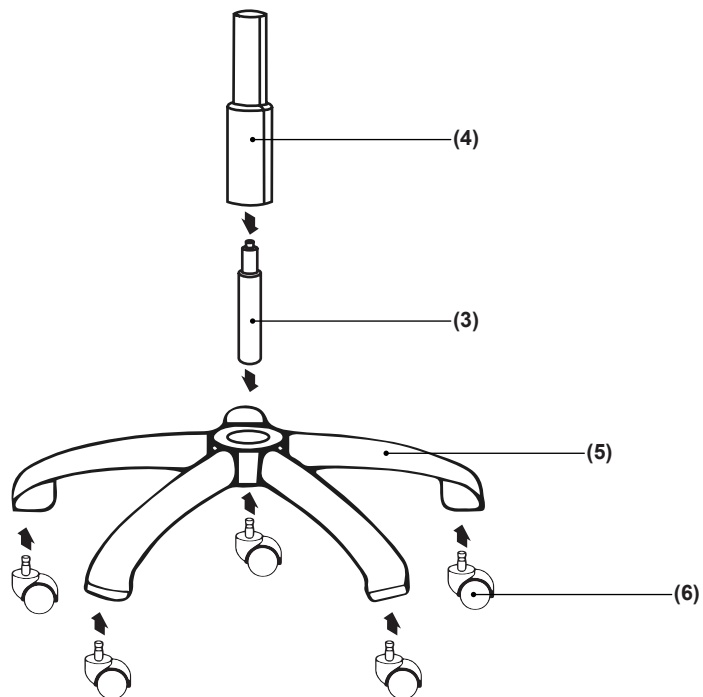

ASSEMBLY INSTRUCTIONS

STEP 2

Fitting the Seat

Carefully locate the seat **(2)** onto the base unit.

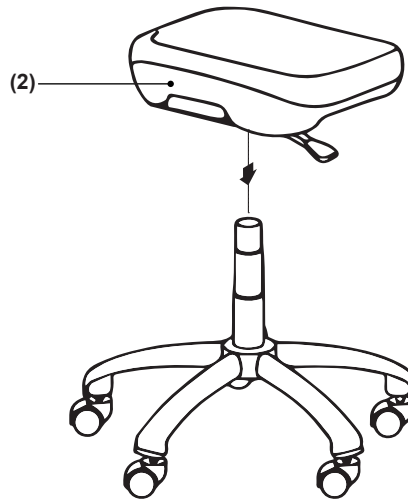

STEP 3

Fitting the Backrest

Slide the mechanism cover **(7)** into the backrest **(1)**.

Use bolts **(B)** and washer **(C)** to fix the the backrest **(1)** into the base unit.

